

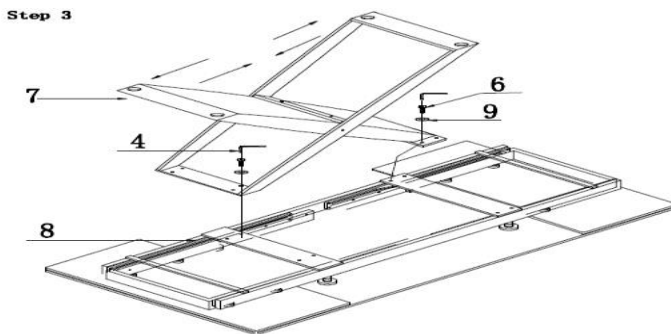

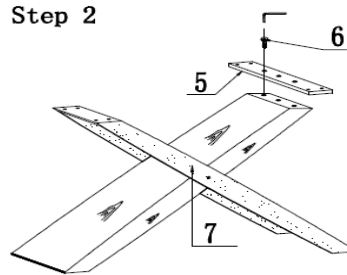

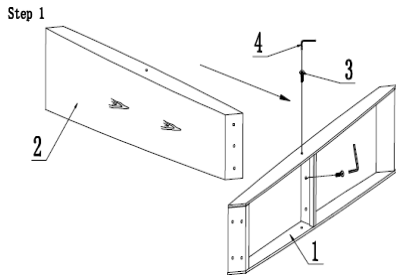



PRODUCT ASSEMBLY INSTRUCTIONS

Item#: T20147B-A(SLL)

Helpers needed to assemble: 2

Estimate time frame to assemble: 30 minutes

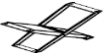

#	Picture	Description	Quantity
1		Metal leg	1
2		Wooden leg	1
3		Bolt(M8*30)	4
4		Allen Key	1
5		Connecting plate	1
6		Bolt(M8*20)	11
7		Table base	1
8		Table top	1
9		Spacer	8

- **Step 1:** Place the wooden leg and metal leg on a safe surface where they can't be scratched or damaged.
- **Step 2:** Put the wooden leg gently and carefully into metal leg as illustration to avoid any scratches.
- **Step 3:** Use (4) bolt (M8 x 30) to tighten the wooden leg and the metal leg with the Allen Key, then use (3) bolt (M8 x 20) to tighten the connecting plate to the wooden leg with the Allen key as seen.
- **Step 3 :** Use (3) bolt (M8 x 20) to tighten the wood leg and the connecting plate with the Allen Key.

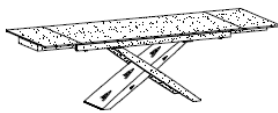

- **Step 4:** Place the table top upside down on a safe surface where the table top can't be scratched or damaged.
- **Step 5:** Use (8) spacer and (8) bolt to tighten the table base and the table top with the Allen Key .
- **Step 6:** Flip the table over upright as seen.
- **Step 7:** Test the table is firmly on the ground and the table does not wobble.
- **Step 8:** Enjoy your new table.

Extension Table Instructions

- **Step 9:** Pull the two side tops apart as seen in the diagram to expose the extension.
- **Step 11:** Align the two side tops and the middle top as seen. Push the side tops in and adjust to reunite the middle top and remove any spacing in between the middle top and side tops. Enjoy your new extension table!

