

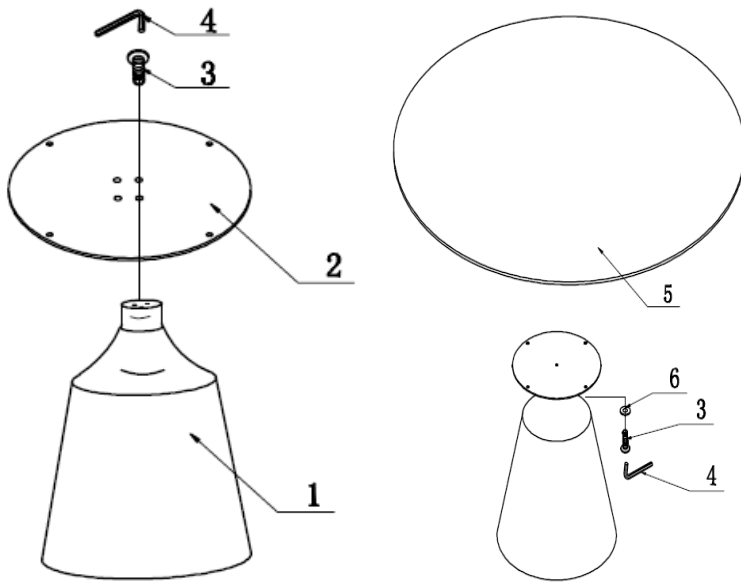





PRODUCT ASSEMBLY INSTRUCTIONS

Item#: T20871R-B

Helpers needed to assemble: 2

Estimate time frame to assemble: 30 minutes



#	Picture	Description	Quantity
1		post	1
2		Supporting panel	1
3		Bolt(M8*30)	8
4		Allen Key	1
5		Tabletop	1
6		Spacer	4

- **Step 1:** Place the post on a safe surface where the table can not be scratched or damaged.
- **Step 2:** Align the supporting panel with the post holes as seen.
- **Step 3:** Use (4) bolt (M8 x 30) to tighten the supporting panel and the post with the Allen Key. Repeat until all 4 sides are bolted
- **Step 4:** Use (4) spacers and (4) bolt (M8 x 30) to tighten the supporting panel and the table top with the Allen Key. Repeat until all 4 sides are bolted

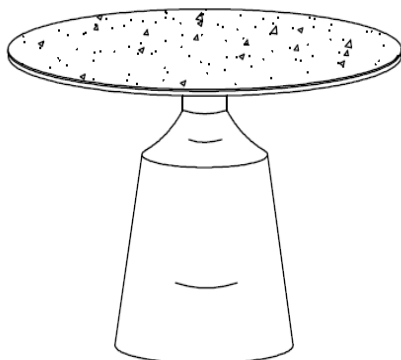

- **Step 5:** Test the table is firmly on the ground and the table does not wiggle.
- **Step 6:** Enjoy your new table.





Product Assembly Instructions

Item#: DC19394C-B

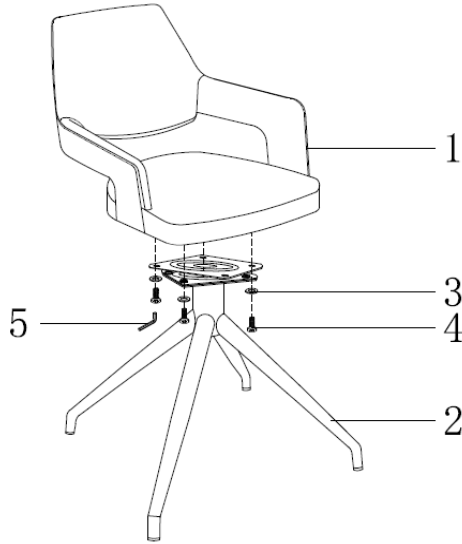
Helpers needed to assemble: 2

Estimate time frame to assemble: 20 minutes



#	Picture	Description	Quantity
1		Seat	1
2		legs	1
3		Spacer	4
4		Bolt(M6X16)	4
5		Allen Key	1

- **Step 1:** On the top of the plate use (4) spacers and (4) bolt (M6 x 16) to tighten the top portion of the plate with the Allen Key. Repeat until all 4 sides are bolted.
- **Step 2:** Turn the dining chair legs upside down to tighten the swivel plate underneath.
- **Step 3:** Once the swivel is secure, we will add the seat under the dining chair to connect the seat to the legs.



- **Step 4:** Flip the dining chair over upright as seen.
- **Step 5:** Test the dining chair is firmly on the ground and the seat does not wiggle.
- **Step 6:** Sit and enjoy your new dining chair.