

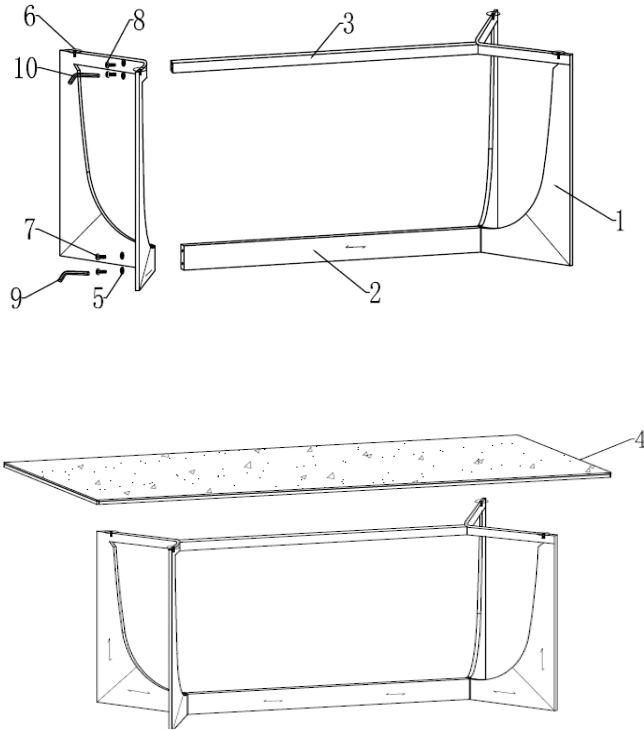









PRODUCT ASSEMBLY INSTRUCTIONS

Item#: T21962A-C

Helpers needed to assemble: 2

Estimate time frame to assemble: 30 minutes



#	Picture	Description	Quantity
1		Metal leg	2
2		Connecting tube(bottom)	1
3		Connecting tube(upper)	1
4		Table top	1
5		Spacer	4
6		sucker	4
7		Bolt((M8*25)	4
8		Bolt((M6*25)	4
9		Allen Key(5#)	1
10		Allen Key(4#)	1

- **Step 1:** Place the metal leg on a safe surface where they can't be scratched or damaged.
- **Step 2:** Use (4) spacer and (2) bolt (M6*25)/(M8*25) to tighten the upper/bottom connecting tube and metal leg with the Allen Key. Repeat until all sides are bolted.
- **Step 3:** Place (4) sucker on the metal leg's hole.
- **Step 4:** Put the table top on the table base, and make sure that it connects with the suckers firmly.

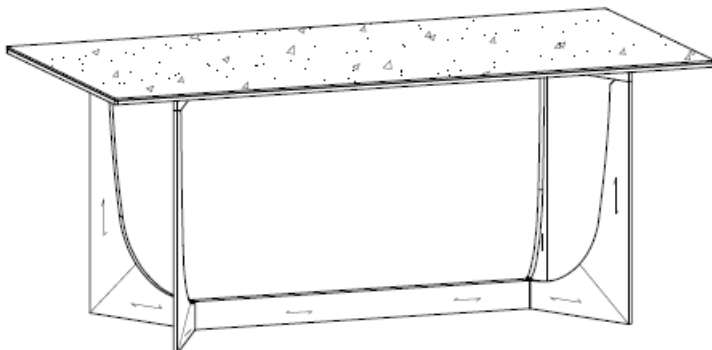

- **Step 5:** Test the table is firmly on the ground and the table does not wobble.
- **Step 6:** Enjoy your new table.





Product Assembly Instructions

Item#: DC19380D-B

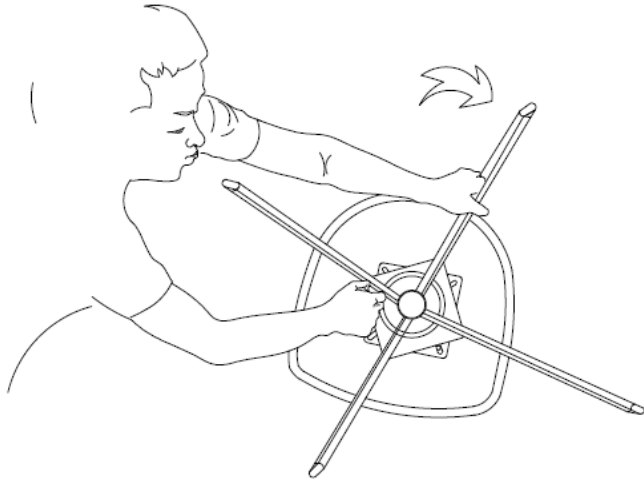
Helpers needed to assemble: 2

Estimate time frame to assemble: 20 minutes



#	Picture	Description	Quantity
1		Seat	1
2		legs	1
3		Spacer	4
4		Bolt(M6X16)	4
5		Allen Key	1

- **Step 1:** On the top of the plate use (4) spacers and (4) bolt (M6 x 16) to tighten the top portion of the plate with the Allen Key. Repeat until all 4 sides are bolted.
- **Step 2:** Turn the dining chair legs upside down to tighten the swivel plate underneath.
- **Step 3:** Once the swivel is secure, we will add the seat under the dining chair to connect the seat to the legs.

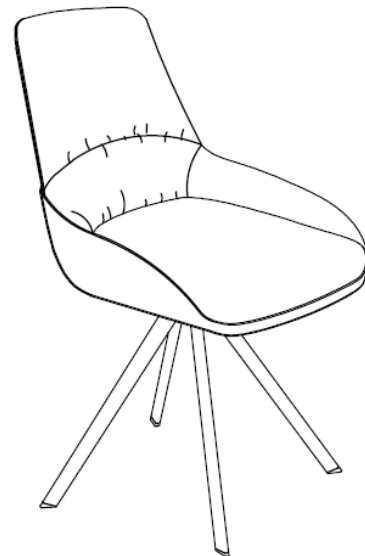
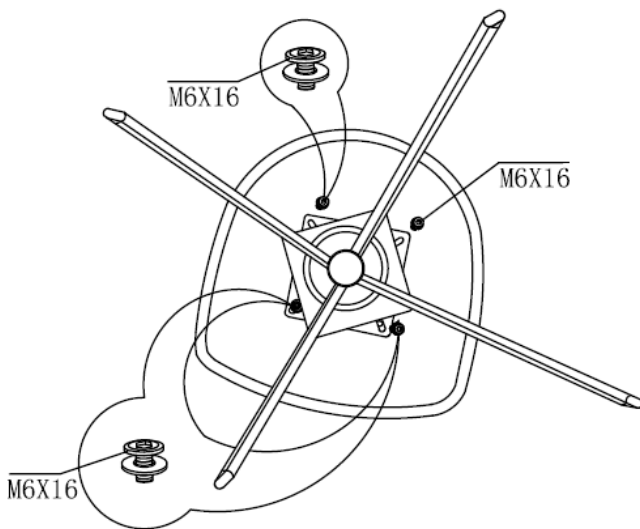

- **Step 4:** Flip the dining chair over upright as seen.
- **Step 5:** Test the dining chair is firmly on the ground and the seat does not wobble.
- **Step 6:** Sit and enjoy your new dining chair.