

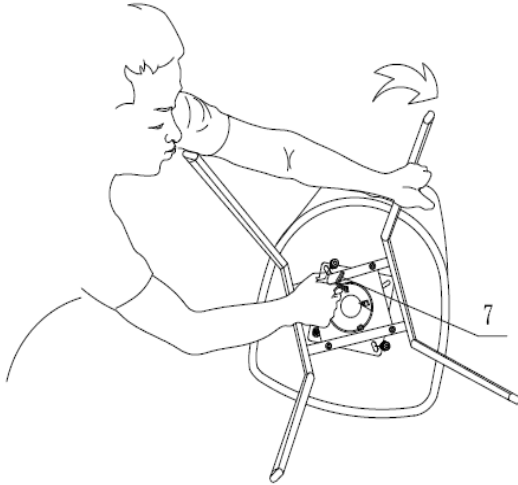





Product Assembly Instructions

Item#: DC19094F-B

Helpers needed to assemble: 2

Estimate time frame to assemble: 20 minutes



#	Picture	Description	Quantity
1		Seat	1
2		legs	1
3		Spacer	4
4		Bolt(M6X16)	2
5		Bolt(M6X20)	2
6		Nut(Ø20*5*Ø8)	2
7		Allen Key	2

- **Step 1:** On the top of the plate use (4) spacers and (4) bolt (M6 x 16 & M6 x 20) to tighten the top portion of the plate with the Allen Key. Repeat until all 4 sides are bolted.
- **Step 2:** Turn the dining chair legs upside down to tighten the swivel plate underneath.
- **Step 3:** Once the swivel is secure, we will add the seat under the dining chair to connect the seat to the legs.

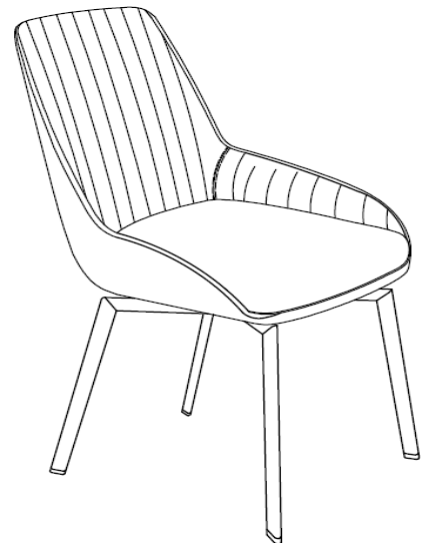
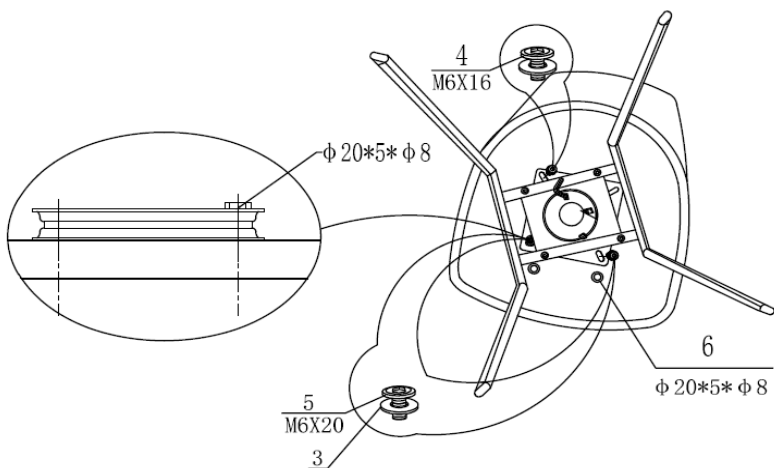

- **Step 4:** Flip the dining chair over upright as seen.
- **Step 5:** Test the dining chair is firmly on the ground and the seat does not wiggle.
- **Step 6:** Sit and enjoy your new dining chair.