

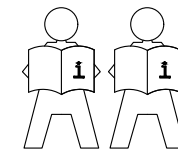

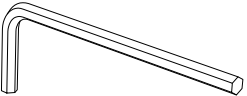

# ASSEMBLY INSTRUCTION

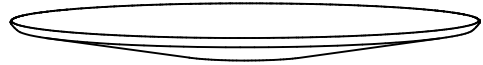

<b>1</b> x1  Allen Key	<b>A</b> x1 
<b>2</b> x1  (already on base)	
<b>3</b> x4  Bolt M8x20mm (4 already on base)	Top
<b>4</b> x4  Bolt M8x25mm	
<b>5</b> x4  Spring Washer	<b>B</b> x1 
<b>6</b> x4  Washer	
<b>7</b> x2  Located Bolt M8x50mm	
Base	

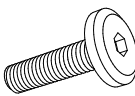
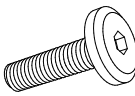

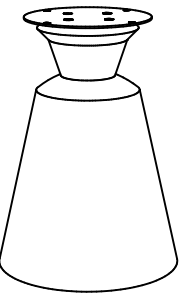
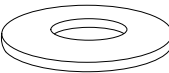
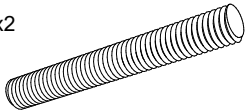
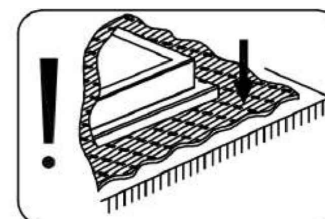
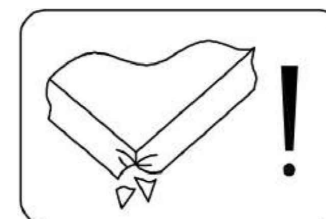
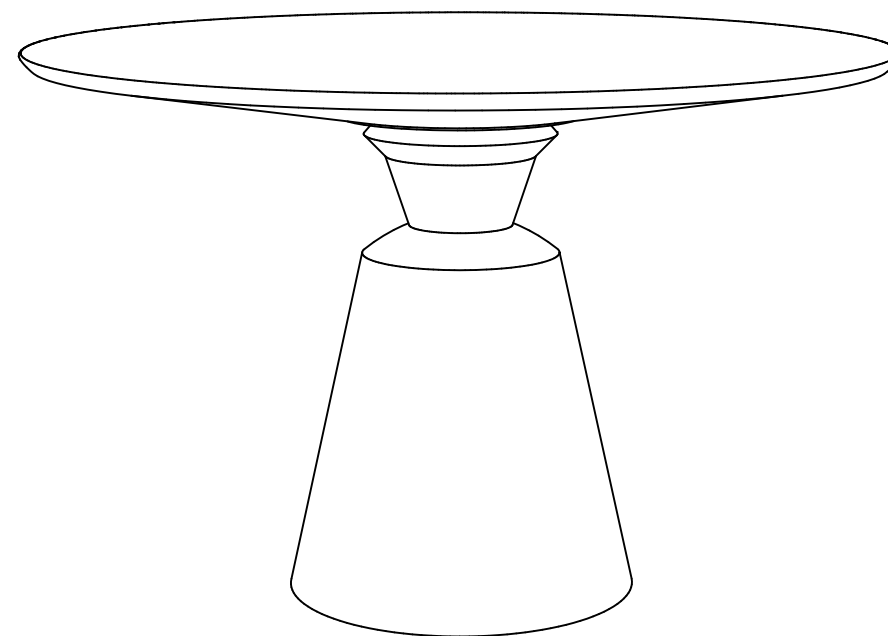
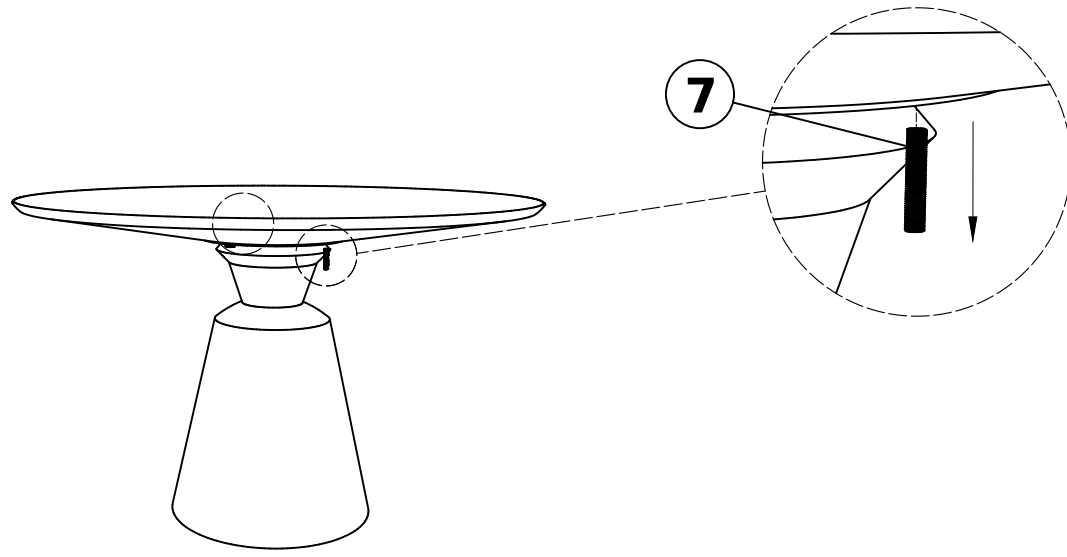
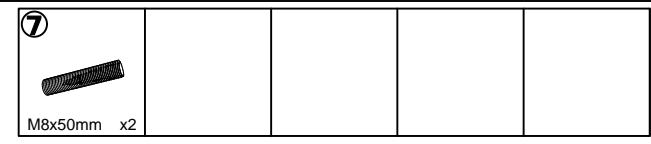
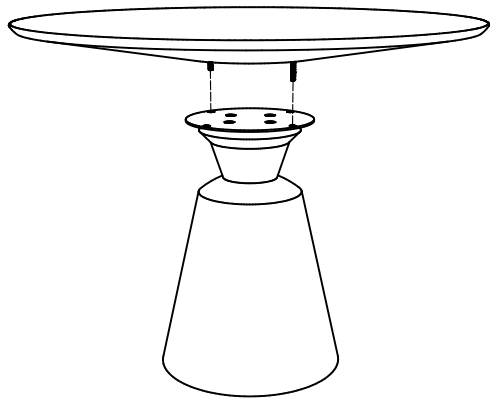
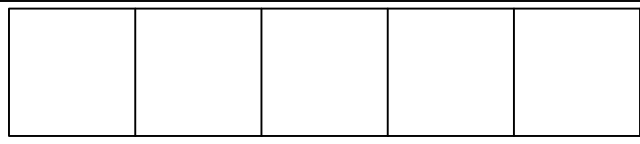
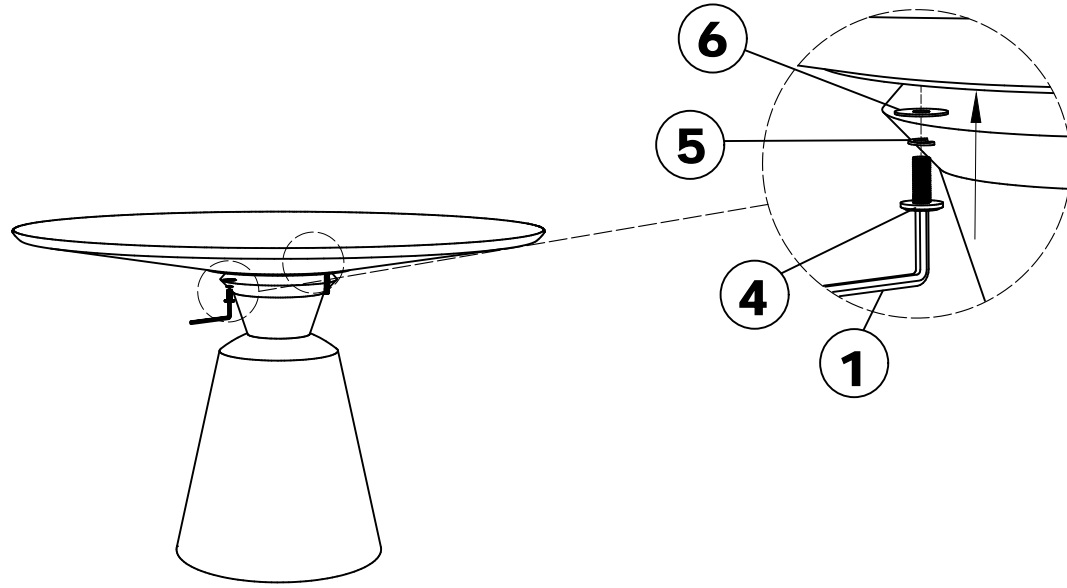
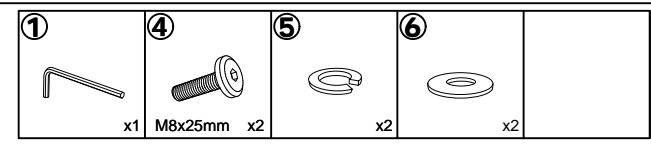
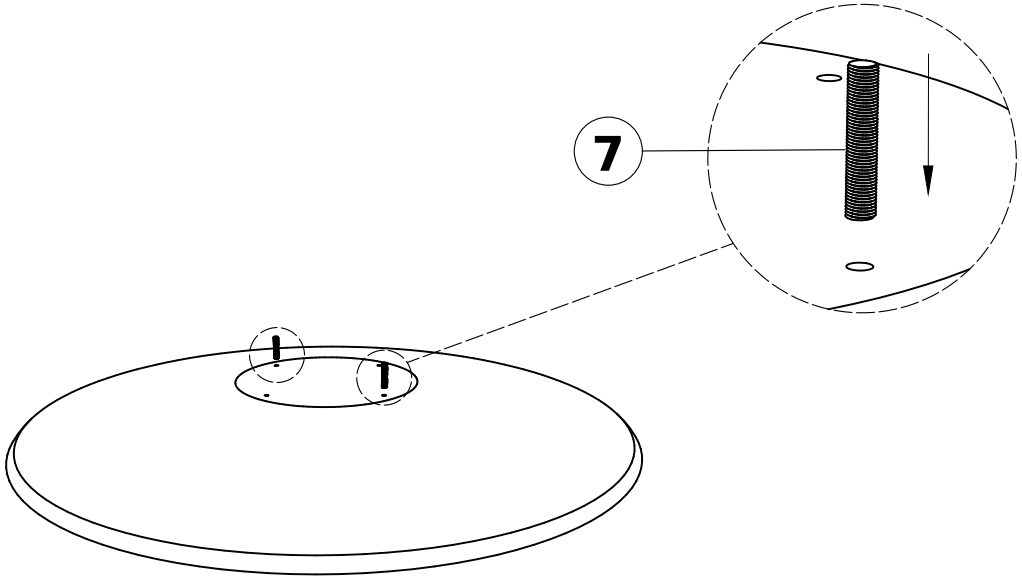
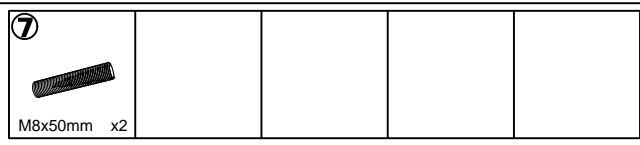

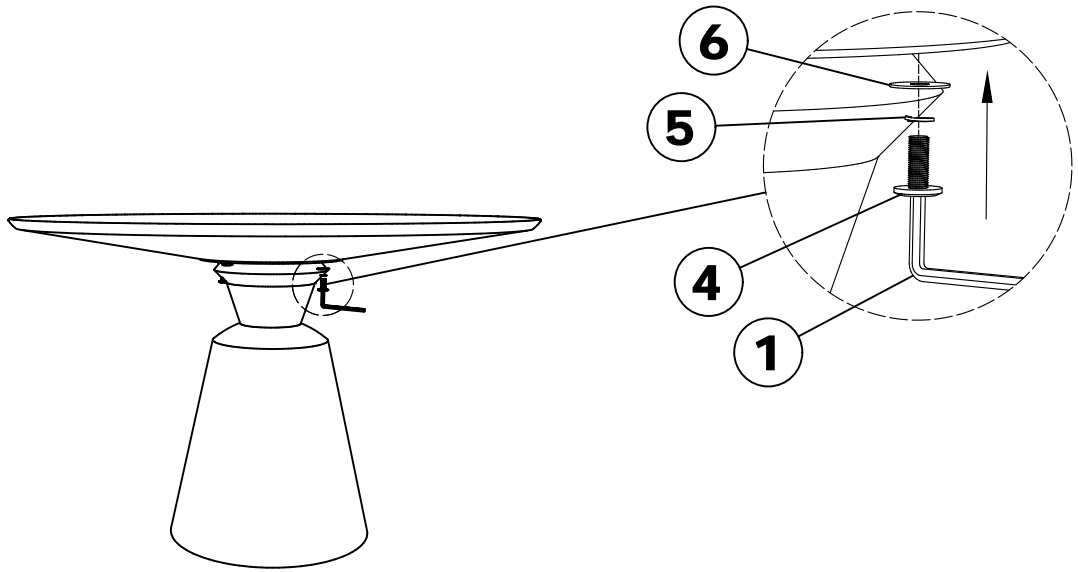
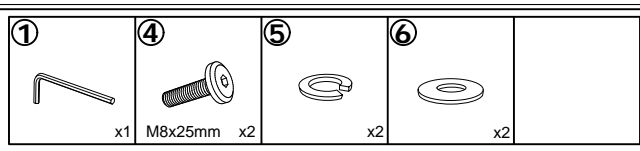

COMPLETE

