

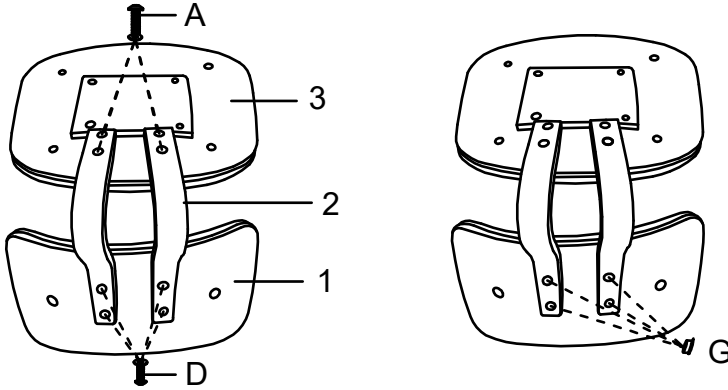















Product Assembly Instructions

Item#: Pico Swivel Chair

Helpers needed to assemble: 2
 Estimate time frame to assemble: 25 minutes



- * **Step 1:** Use 4pcs D (Bolts+Washers) to tighten Support Bar (2) and Back (1). Use 4pcs A (Bolts+Washers) to tighten Support Bar (2) and Seat (3).
- * **Step 2:** Inserts 4pcs Plugs (G) into Back support (2) as shown.
- * **Step 3:** Loosely tighten the 4pcs Leg (4) to the Footrest (5) with Bolts (B M6x25).
- * **Step 4:** Use 4pcs bolt (C M6x20) to tighten the Plate (7) to Leg (4) with Allen Key.
- * **Step 5:** Turn the barstool legs upside and use 4pcs bolt (C M6x20) to tighten the Swivel Plate (6) with Allen Key. Make sure the plate aligns with the bolt holes on barstool legs base. Then ensure all bolts are fully tightened on previous steps.
- * **Step 6:** Once the swivel is secure, we will add the seat under the barstool to connect the seat to the legs. Place 2pcs Washers (F) in the front of the seat. Use 2pcs bolts (C M6x20) and 2pcs bolt (E M6x16) to tighten the swivel plate and seat. Make sure the plate aligns with the washers and bolt holes on the seat.

#	Picture	Description	Quantity
1		Back	1
2		Support Bar	2
3		Seat	1
4		Leg	4
5		Footrest	1
6		Swivel Plate	1
7		Plate	1
A		Bolts(M6x30) Washers(M6x14x1)	4+1EXT
B		Bolts(M6x25)	4+1EXT
C		Bolts(M6x20)	10+1EXT
D		Bolts(M6x20) Washers(M6x14x1)	4+1EXT
E		Bolts(M6x16)	2+1EXT
F		Washers	2
G		Plug	8
L		Allen Key	1

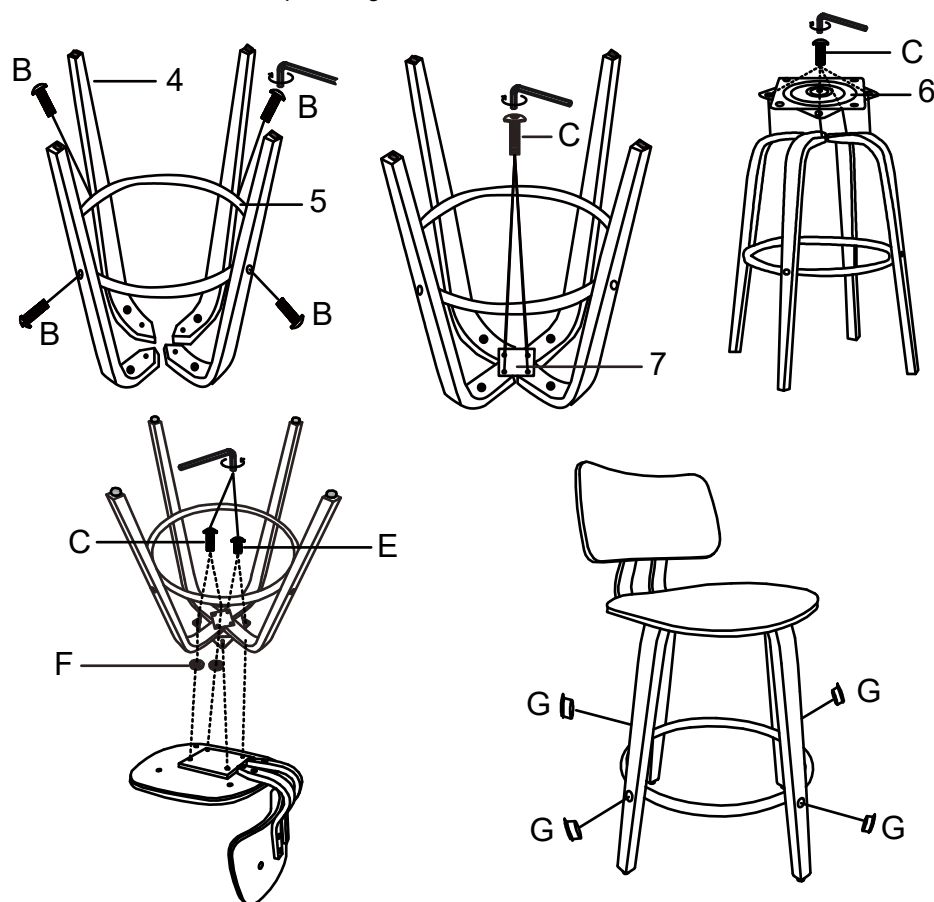

- * **Step 7:** Flip the barstool over upright as seen. Insert 4pcs Plugs (G) in the leg as shown. Adjust the foot nails if legs are uneven.
- * **Step 8:** Test the barstool is firmly on the ground and the seat does not wiggle.
- * **Step 9:** Sit and enjoy your new barstool.

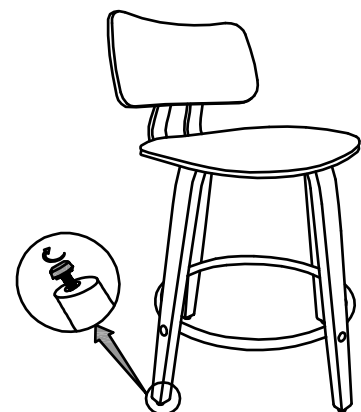

* Keep the Allen Key and Tighten all screws each 3 months for safety concern!