

A: Top x1

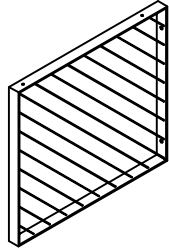

B: Metal Legs x2

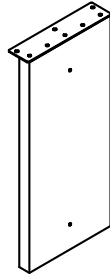

C: Wood Legs x2



D: Bolt M6*20mm x7



E: Washer x7



F: Allen wrench x1

STEP 1

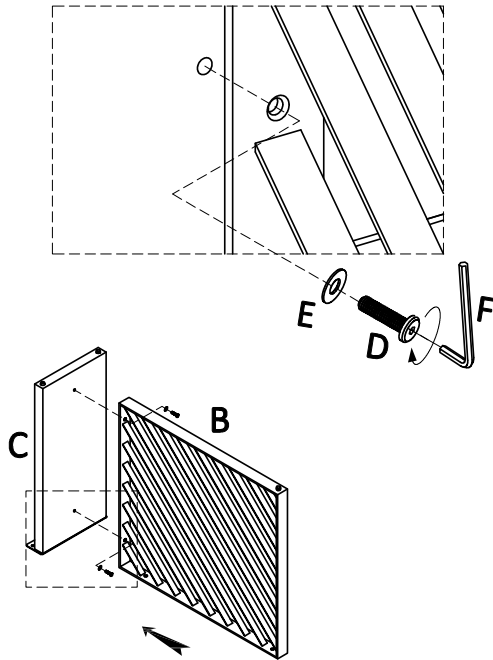

STEP 2

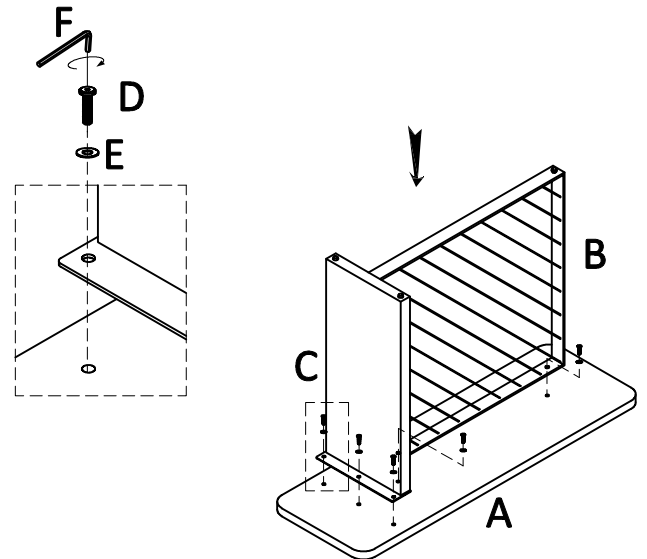

STEP 3

