

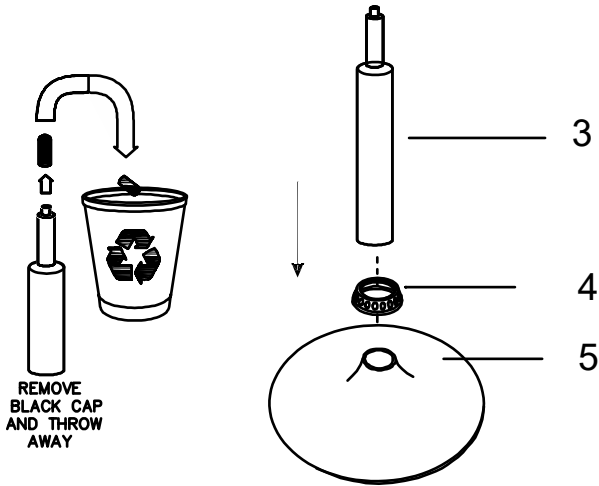





# Product Assembly Instructions

## Item#: Lydia Adjustable Barstool

Helpers needed to assemble: 2

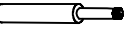
Estimate time frame to assemble: 10 minutes



#	Picture	Description	Quantity
1		Seat	1
2		Footrest	1
3		Hydraulic	1
4		Decorative ring	1
5		Base	1
A		Bolts(M6x16)	4+1EXT
G		Allen Key	1

- \* **Step 1:** Remove the black Cap on Hydraulic(3) and throw away.
- \* **Step 2:** Put the Decorative ring (4) on the top of the Base (5).
- \* **Step 3:** Insert the Hydraulic (3) into the Base (5) through Decorative ring (4).
- \* **Step 4:** Carefully turn the Seat upside down on a smooth and scratch-free surface. Place Footrest (2) on the bottom of the chair as shown. Attach 4 Bolts (A) in the pre-drilled holes until all in position. Tighten all bolts with Allen Key.

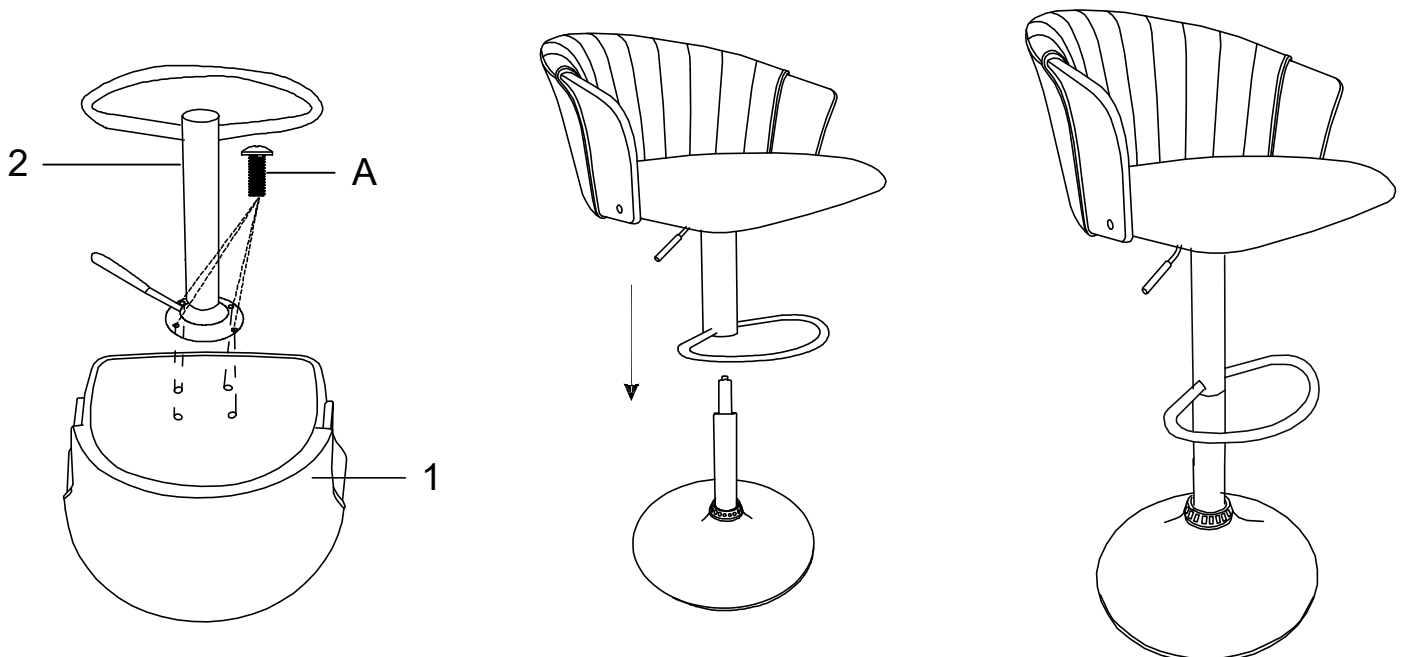

- \* **Step 5:** Flip the barstool seat over upright as seen. Insert the Hydraulic (3) into Footrest (2).
- \* **Step 6:** Test the barstool is firmly on the ground and the seat does not wiggle.
- \* **Step 7:** Sit and enjoy your new barstool.

\* Keep the Allen Key and Tighten all screws each 3 months for safety concern!