

ASSEMBLY INSTRUCTION

SDR-2908 / KARTER BS

(1) ×1

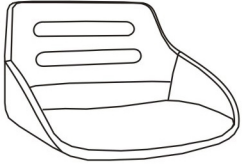

(5) ×1

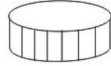

(2) ×1

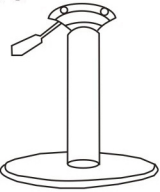

(6) ×4 +1EXTRA

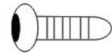

(3) ×1



(7) ×1



(4) ×1

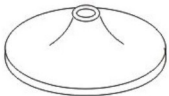

1

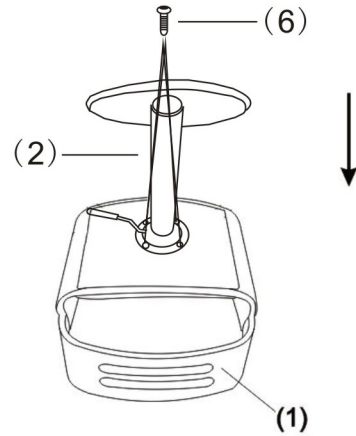

2

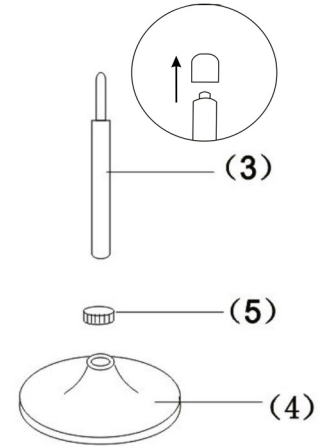

3

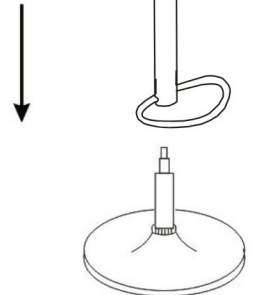

4

