







# Assembly Instruction

1*1		A*4+1EXT	 M6*16MM
2*1		G*1	 M6
3*1			
4*1			
5*1			

**STEP 1**

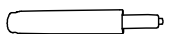

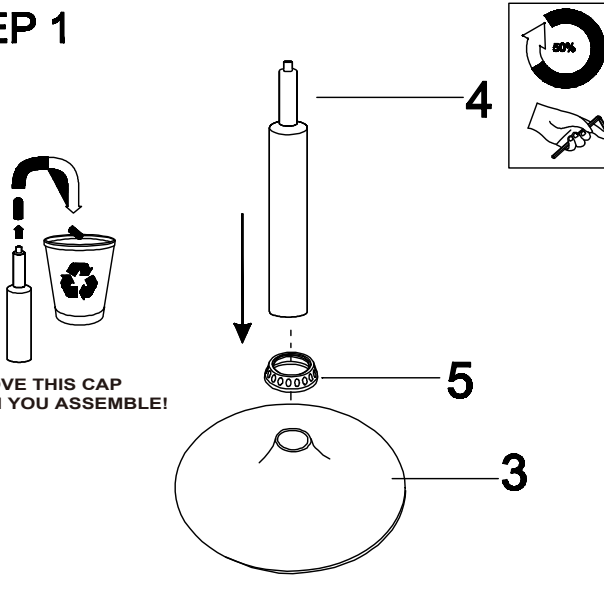
REMOVE THIS CAP WHEN YOU ASSEMBLE!

50%

**STEP 2**

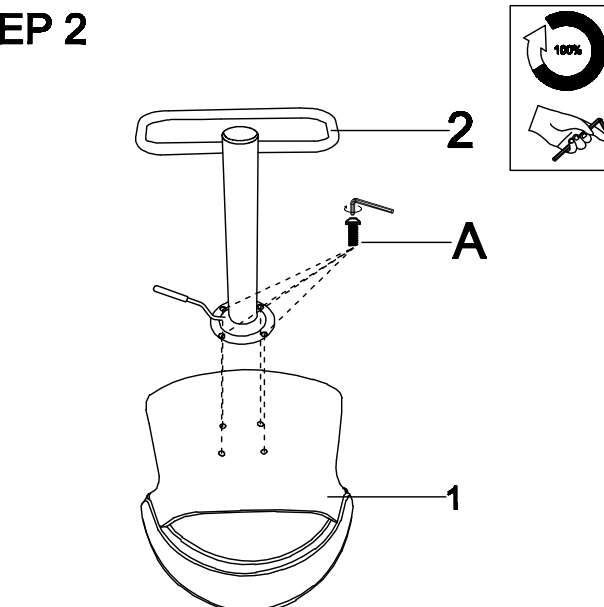

100%

**STEP 3**

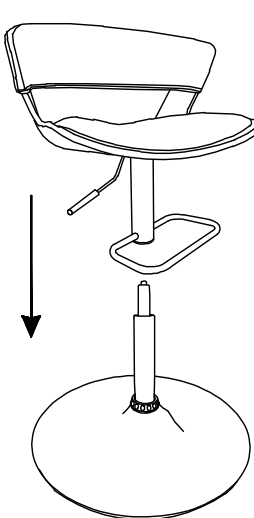

**STEP 4**

