

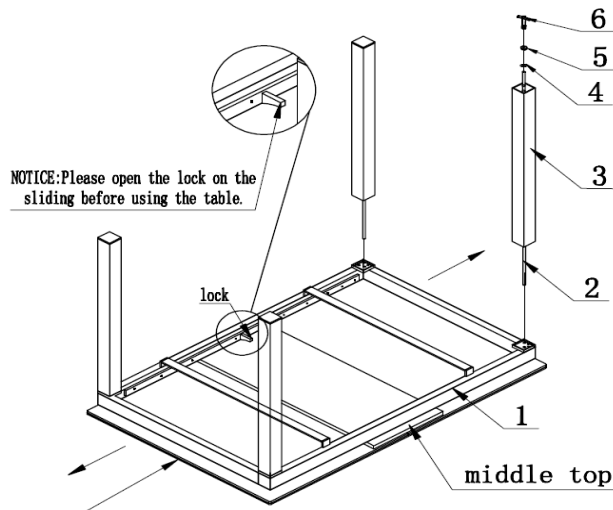







PRODUCT ASSEMBLY INSTRUCTIONS

Item#: T8408B-A(ZT)

Helpers needed to assemble: 2

Estimate time frame to assemble: 30 minutes



#	Picture	Description	Quantity
1		Tabletop	1
2		Long bolt	8
3		Legs	4
4		spacer	8
5		Nut	8
6		Wrench	1
7		Leg's cover	4

- **Step 1:** Place the table top upside down on a safe surface where the table top can't be scratched or damaged.
- **Step 2:** Fix the long bolts to the table top as seen, then insert the legs through the long bolts, use (8) spacer and (8) nut to tighten the leg with the wrench. Repeat for each leg until all four legs are screwed in firmly.
- **Step 3:** Use the leg's cover(4) to cover the legs.
- **Step 3:** Put the cover cap to cover the leg hole.

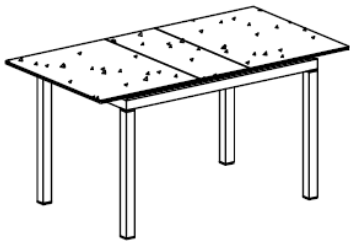

- **Step 4:** Flip the table over upright as seen.
- **Step 6:** Test the table is firmly on the ground and the table does not wobble.
- **Step 7:** Enjoy your new table.

Extension Table Instructions

- **Step 8:** Open the lock on the sliding before extending the middle top.
- **Step 9:** Pull the two side tops apart as seen in the diagram to expose the middle extension.
- **Step 10:** Align the two side tops' and the middle extension top's holes as seen. Push the two side tops in and adjust to reunite the parts of extension top and remove any spacing in between the extension and side tops. Enjoy your new extension table!

Notice: i. Please open the lock on the sliding before opening the top, then lock it after closing the top.
 ii. Please open the lock on the sliding before extending the middle top, then lock it after closing the top.
 iii. Please always remember to open the lock on the sliding, then lock it while using the table.

