

Assembly Instructions - Felicity Power Reclining Sofa

STEP 1

The wood feet and transformer are located at the rear of the Seat.



STEP 2

Take all feet and place the plastic washer on to bolt of each plastic foot.

STEP 3

Attach each leg to the corresponding pre-drilled holes by hand turning in clockwise direction until is tight.

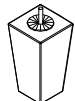
NOTE: Please do not over tighten the feet, as it could cause damage.

PARTS LIST			
Front wood Leg 2 pieces		Plastic Leg 2 pieces	
Rear wood Leg 2 pieces			

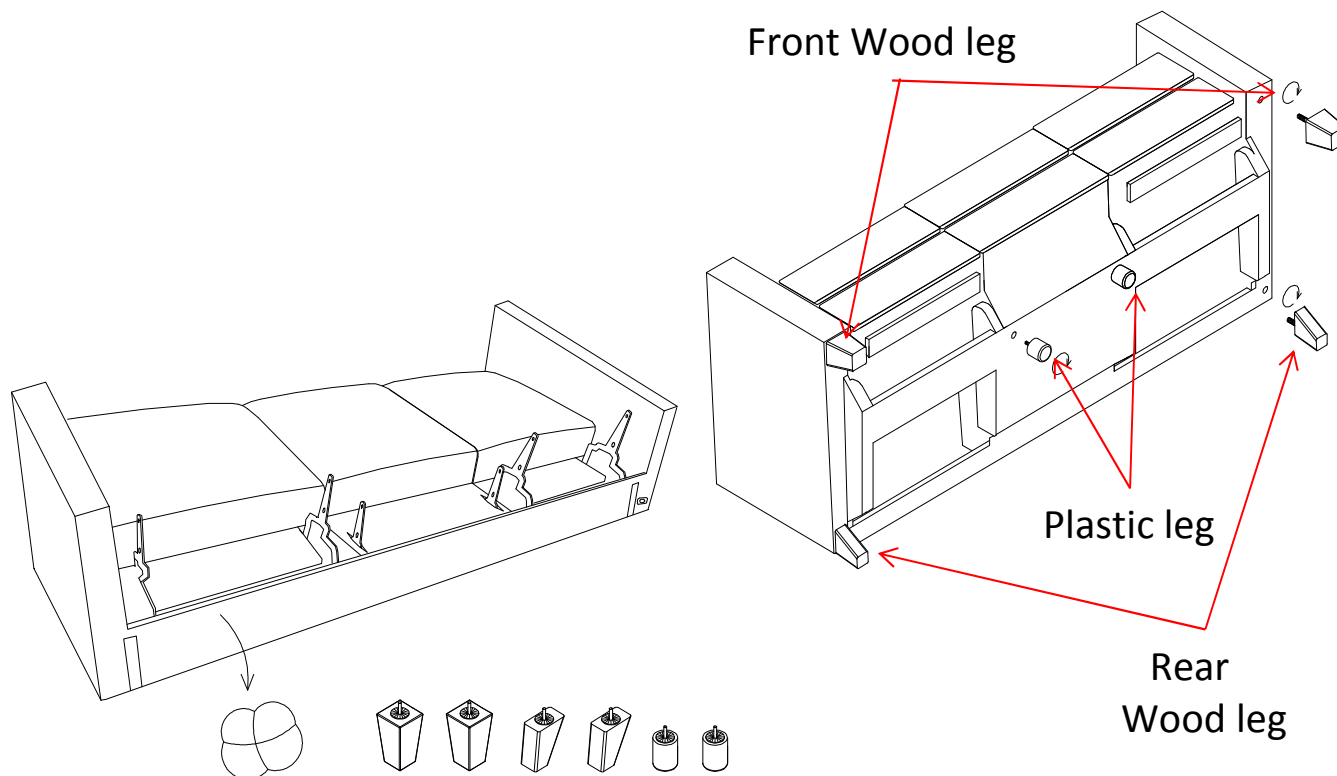

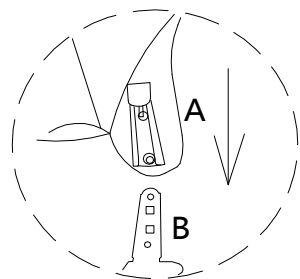

1、 Slide the metal receiver over the metal post. Press both sides of back firmly downward until locked in place.

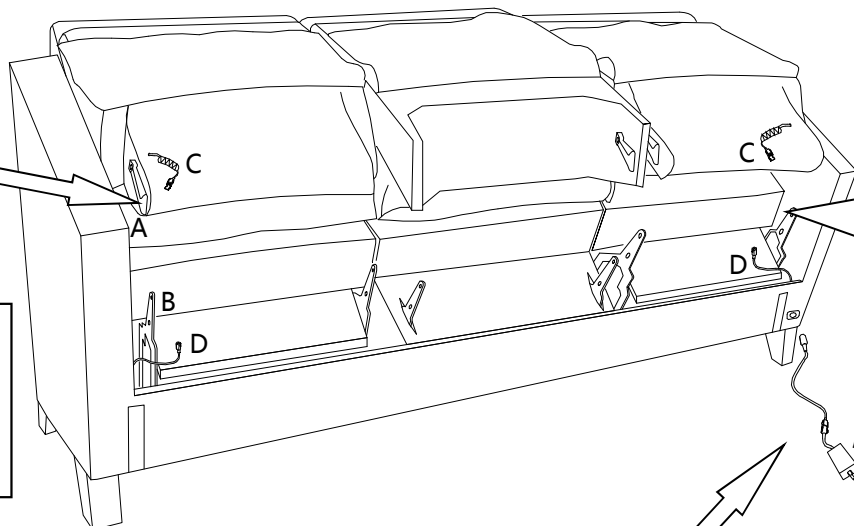

2、 Locate the power cord C attached to the bottom back and connect to plug D located at the rear of seat.

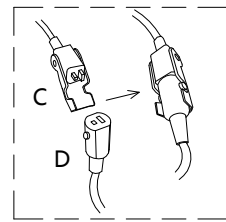

3、 Locate the transformer P and connect to DC Port located at the rear of arm.

**4、 KD Wings (If applicable)
Insert the male KD Bracket into the slot of the female Bracket pressing firmly downward until the frame is tight.**

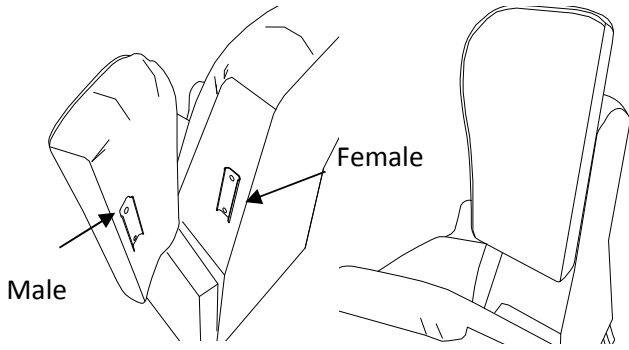

Note:
Make sure all PLUGS are connected on the product before plugging power cord into power outlet. If not damage can occur.
The USB ports (where applicable) are designed with working voltage of 5V, and can NOT be used to supply power for laptop computers (neither PC or Mac). Plugging a laptop computer to the USB port may end up damaging either the computer or the USB port due to unmatched working voltage.