

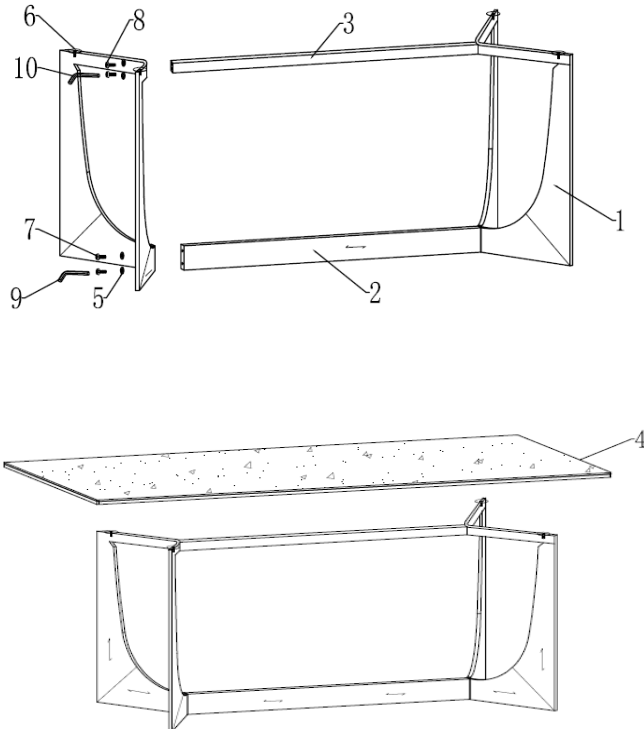









# PRODUCT ASSEMBLY INSTRUCTIONS

## Item#: T21962A-C

Helpers needed to assemble: 2

Estimate time frame to assemble: 30 minutes



#	Picture	Description	Quantity
1		Metal leg	2
2		Connecting tube(bottom)	1
3		Connecting tube(upper)	1
4		Table top	1
5		Spacer	4
6		sucker	4
7		Bolt((M8*25)	4
8		Bolt((M6*25)	4
9		Allen Key(5#)	1
10		Allen Key(4#)	1

- **Step 1:** Place the metal leg on a safe surface where they can't be scratched or damaged.
- **Step 2:** Use (4) spacer and (2) bolt (M6\*25)/(M8\*25) to tighten the upper/bottom connecting tube and metal leg with the Allen Key. Repeat until all sides are bolted.
- **Step 3:** Place (4) sucker on the metal leg's hole.
- **Step 4:** Put the table top on the table base, and make sure that it connects with the suckers firmly.

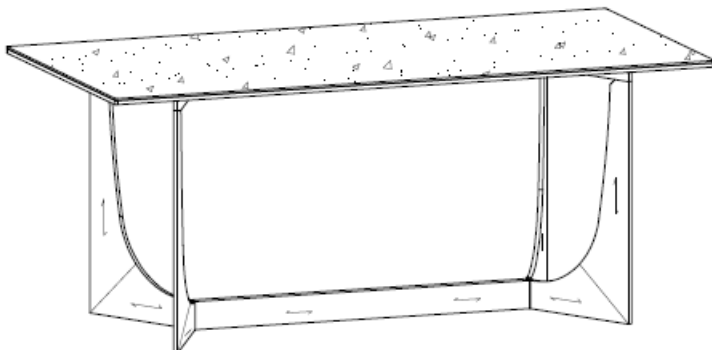

- **Step 5:** Test the table is firmly on the ground and the table does not wobble.
- **Step 6:** Enjoy your new table.