

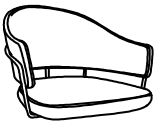





Assmebly Instruction

A*1		C*2+1EXT	 M6*20MM
B*1		D*2+1EXT	 M6*16MM
		E*2	
		F*1	 M6

STEP1

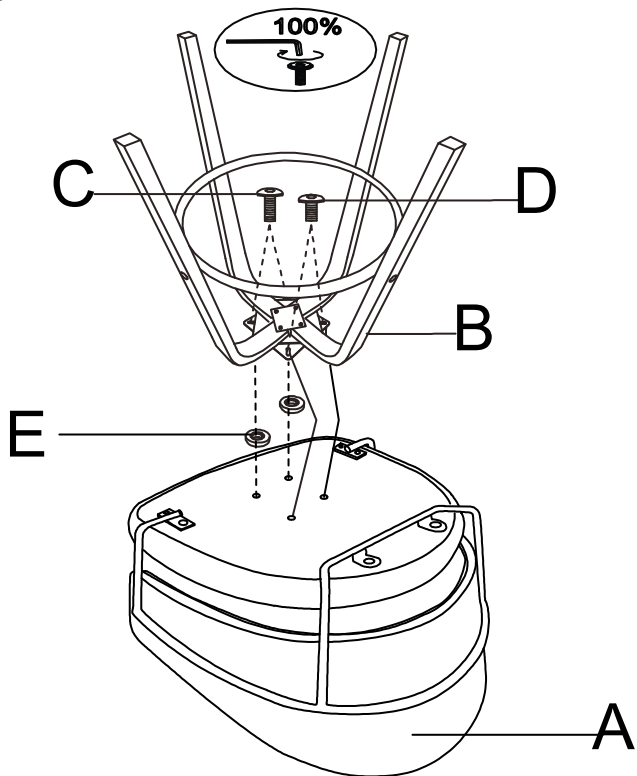

STEP2

