

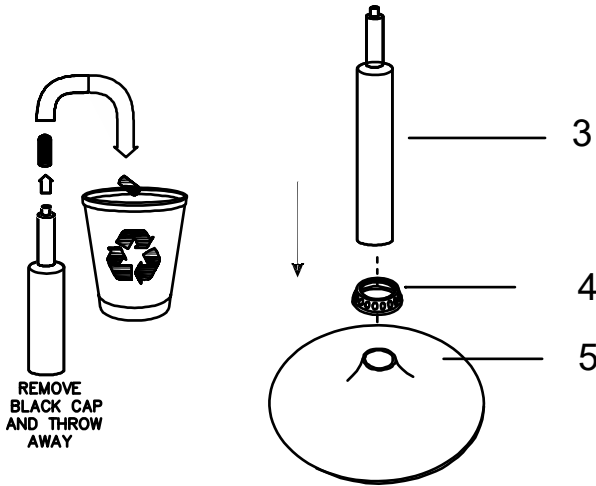





Product Assembly Instructions

Item#: Calista Adjustable Barstool

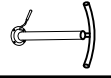
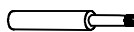
Helpers needed to assemble: 2
 Estimate time frame to assemble: 10 minutes



#	Picture	Description	Quantity
1		Seat	1
2		Footrest	1
3		Hydraulic	1
4		Decorative ring	1
5		Base	1
A		Bolts(M6x16)	4+1EXT
G		Allen Key	1

- * Step 1: Remove the black Cap on Hydraulic(3) and throw away.
- * Step 2: Put the Decorative ring (4) on the top of the Base (5).
- * Step 3: Insert the Hydraulic (3) into the Base (5) through Decorative ring (4).
- * Step 4: Carefully turn the Seat upside down on a smooth and scratch-free surface. Place Footrest (2) on the bottom of the chair as shown. Attach 4 Bolts (A) in the pre-drilled holes until all in position. Tighten all bolts with Allen Key.

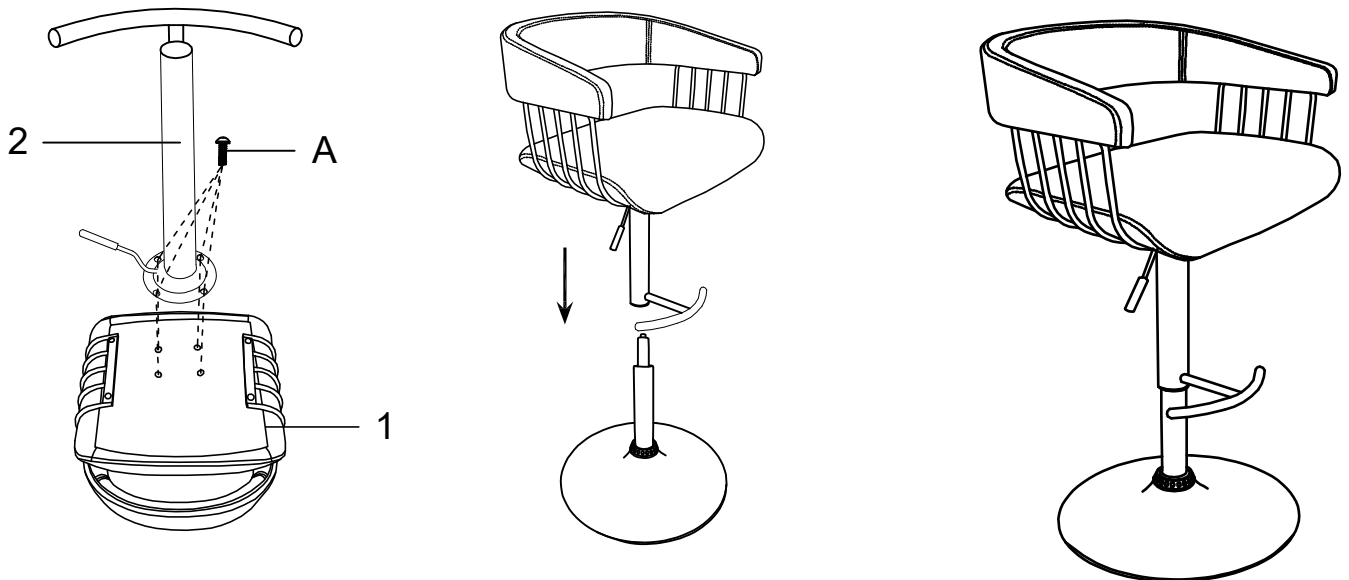

- * Step 5: Flip the barstool seat over upright as seen. Insert the Hydraulic (3) into Footrest (2).
- * Step 6: Test the barstool is firmly on the ground and the seat does not wiggle.
- * Step 7: Sit and enjoy your new barstool.

* Keep the Allen Key and Tighten all screws each 3 months for safety concern!