

Product Assembly Instructions

Item#: ARIAN BARSTOOL

Helpers needed to assemble: 2

Estimate time frame to assemble: 10 minutes







Thank you for purchasing this quality product. Be sure to check all packing material carefully for small parts, which may come loose inside the carton during shipment. Please identify and count all parts and compare with the HARDWARE LIST below.

Caution: Please read instructions carefully before unpacking assembly parts. Sharp, exposed staples can cause injury, therefore, for your protection, please remove any exposed staples used in packing.

Step 1: Turn the barstool legs rightside up and place the seat underneath the barstool to connect the seat to the legs. Place 1pcs flat Washer (3) and 1pcs spring washer(2) on the bolt 1/4" x 1" (1) in the as shown to tighten the swivel plate and seat. Make sure the plate aligns with the washers and bolt holes on the seat.

Step 2: Flip the barstool over upright as seen. Test the barstool is firmly on the ground and the seat does not wiggle.

Step 3: Sit and enjoy your new barstool.

#	Picture	Description	Q'TY
A		Frame leg	1
B		Seat frame	1
1		Ø 1/4" x 1" Bolts	4
2		Ø 1/4" x Ø12 Spring washer	4
3		Ø1/4"x Ø19 Flat washer	4
4		Allen key	1

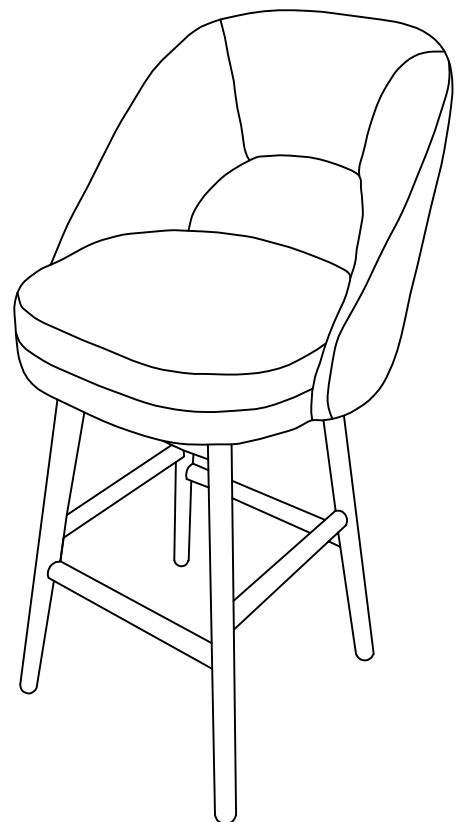
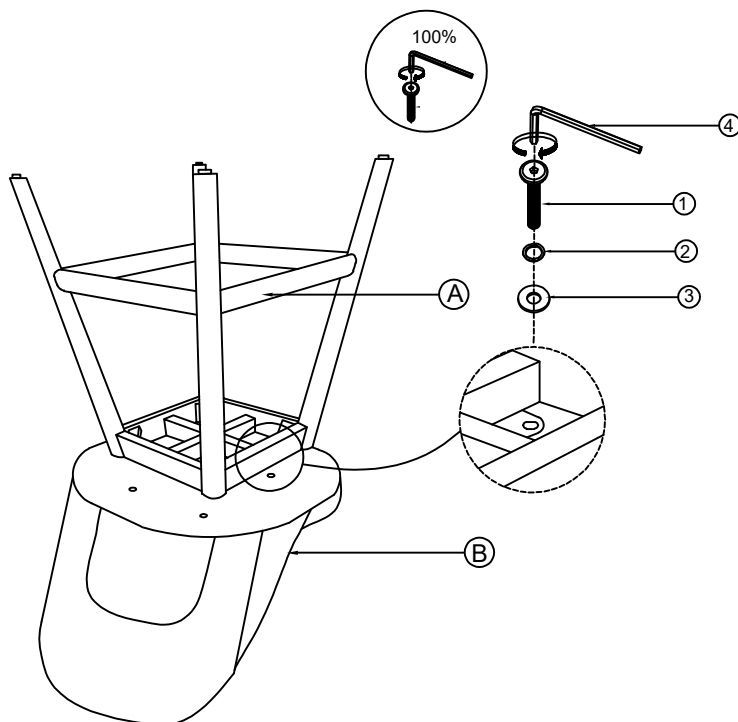

*** Keep the Allen Key and Tighten all screws each 3 months for safety concern!**

1. We recommend to assemble this product with the assistance of another person. This will provide a smooth assembly process, and can help eliminate self injuries or damage to the product during assembly.
2. Please do not over tighten screws or bolts until the assembly is completed.
3. Please put all parts on a smooth, flat surface before assembly, and carefully follow the assembly steps to assemble your newly purchased product correctly and efficiently.