

# JD7558-2 ASSEMBLY INSTRUCTION

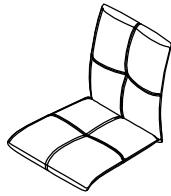

① × 1

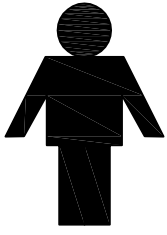

② × 1



M6 × 30

③ × 4



$\phi 16 / \phi 6$

④ × 4

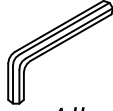
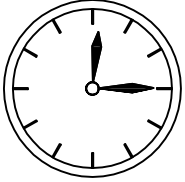

4#

⑤ × 1

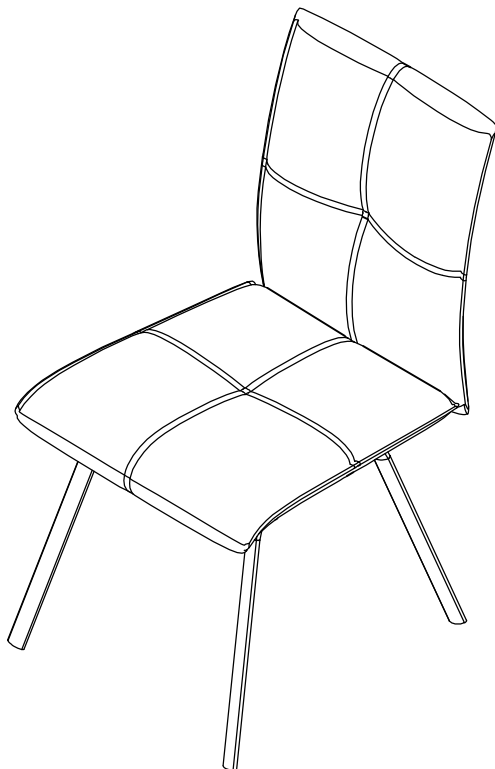
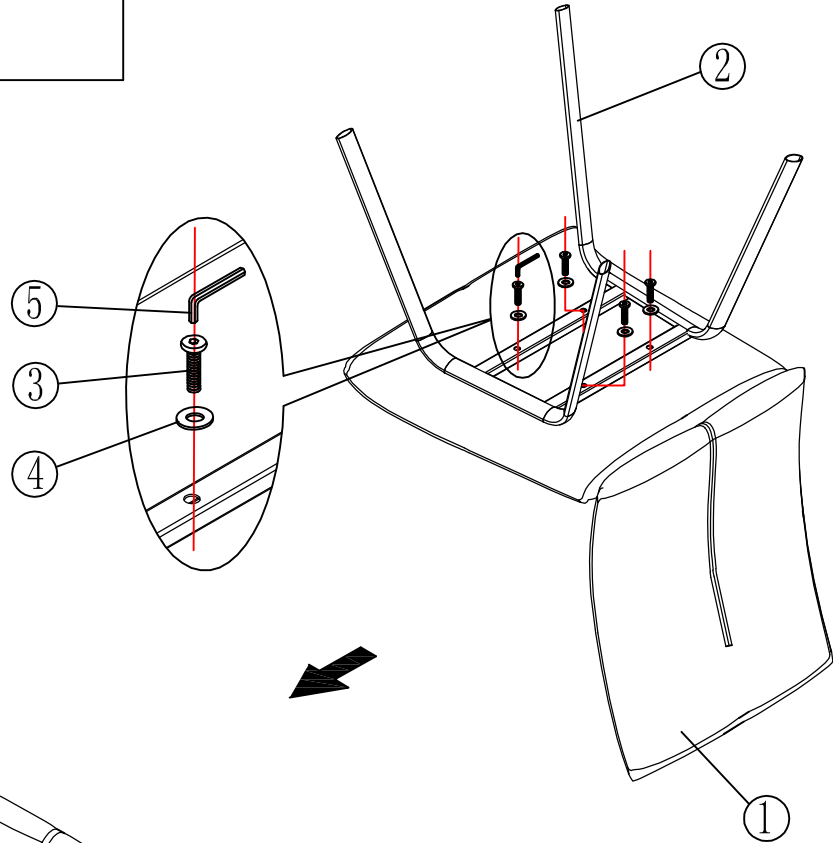

# JA7225 ASSEMBLY INSTRUCTION

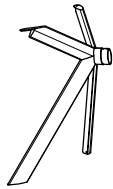
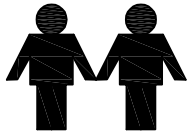

A × 2pcs

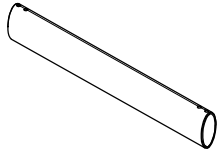

B × 1pc

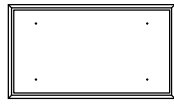

C × 1pc



D × 4pcs  
M8\*16mm

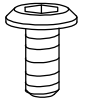

E × 4pcs  
M8\*12mm



F × 4pcs  
φ20\*φ10\*2



G × 1pc  
#6



H × 1pc  
#5

## STEP: 1

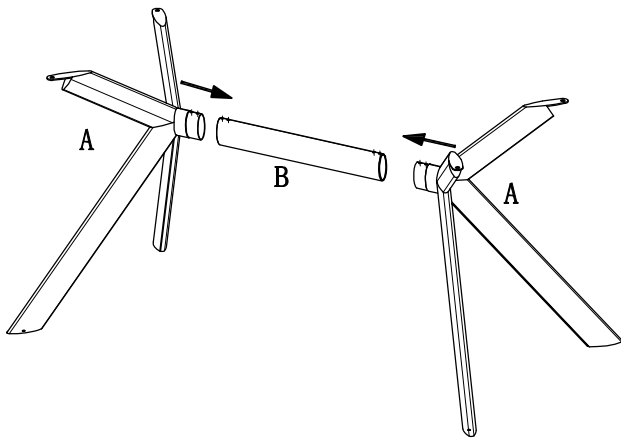

## STEP: 2

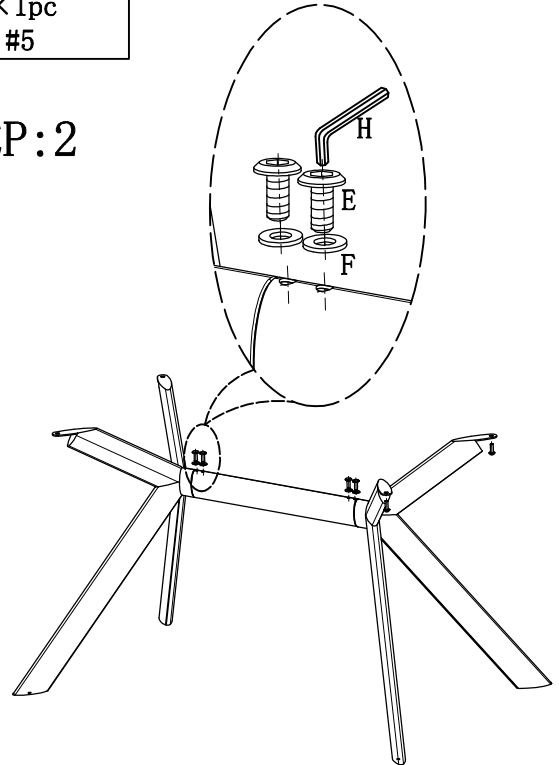

## STEP: 3

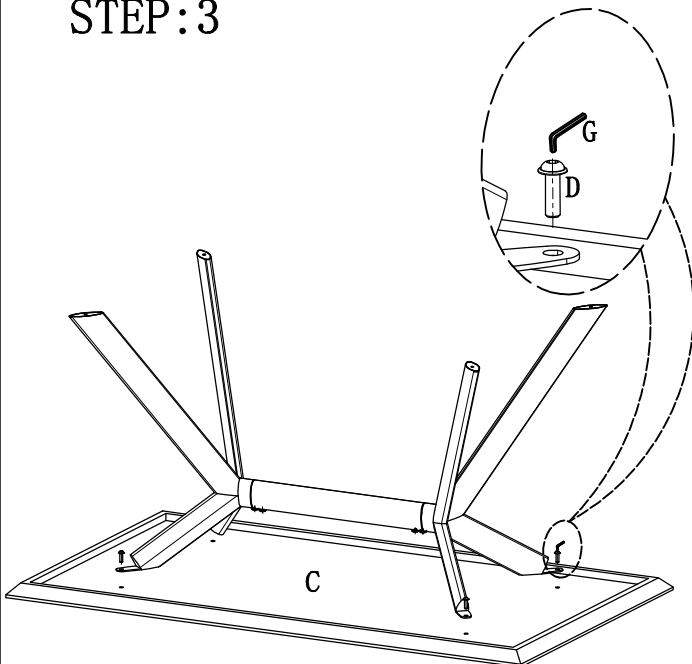

## STEP: 4

