

JDZ8804

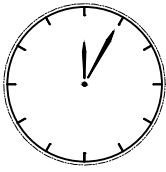

④ x1

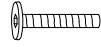

M8x35

③ x8

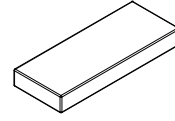

② x1

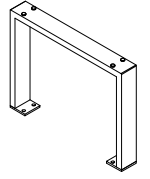

① x2

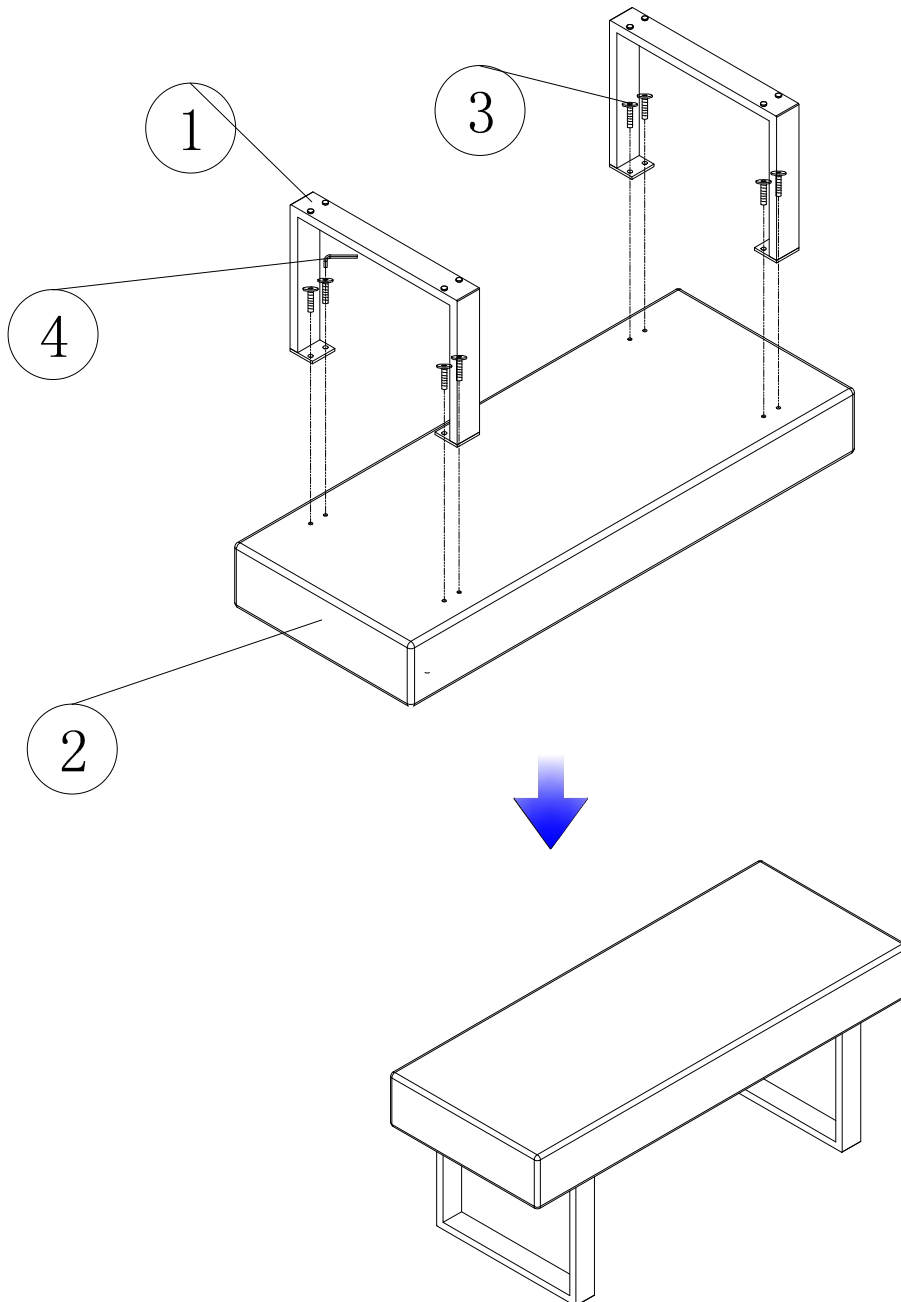

AT903-W ASSEMBLY INSTRUCTION

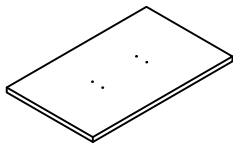
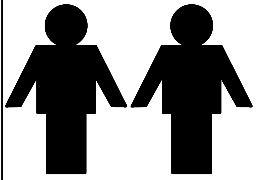

① × 1

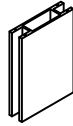

② × 1

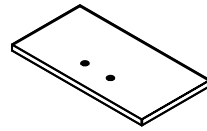

③ × 2



④ × 4

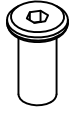

⑤ × 4

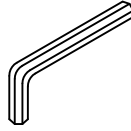

⑥ × 1

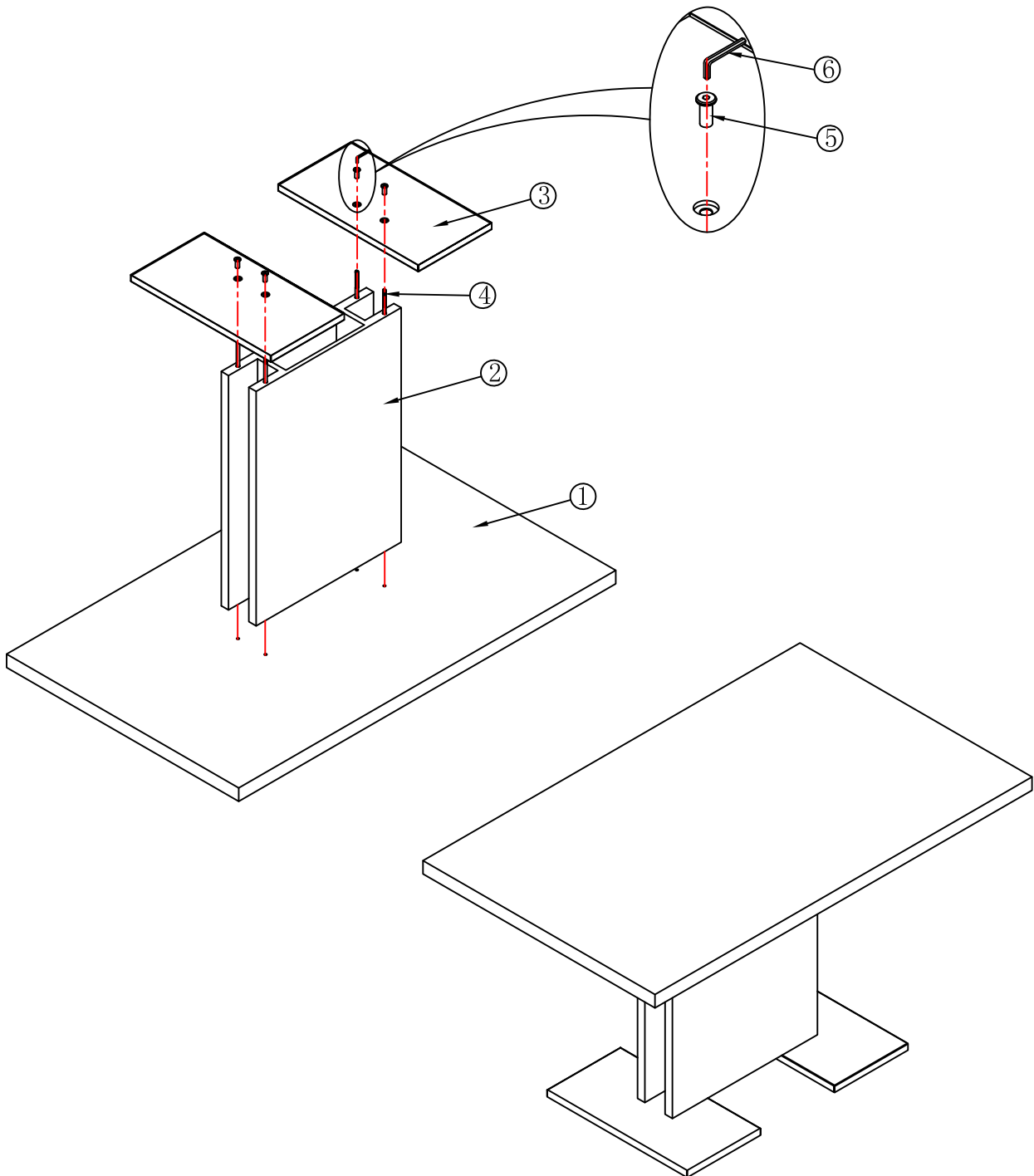

JDZ8804-L

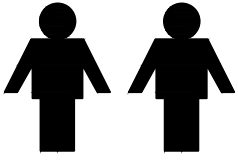

① x1

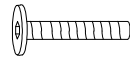

M8x35 ② x16

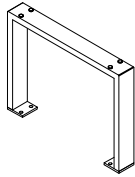
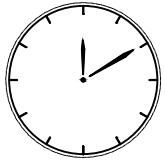
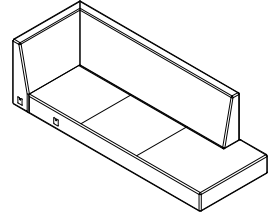

③ x4

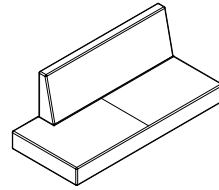

④ x1

⑤ x1

