

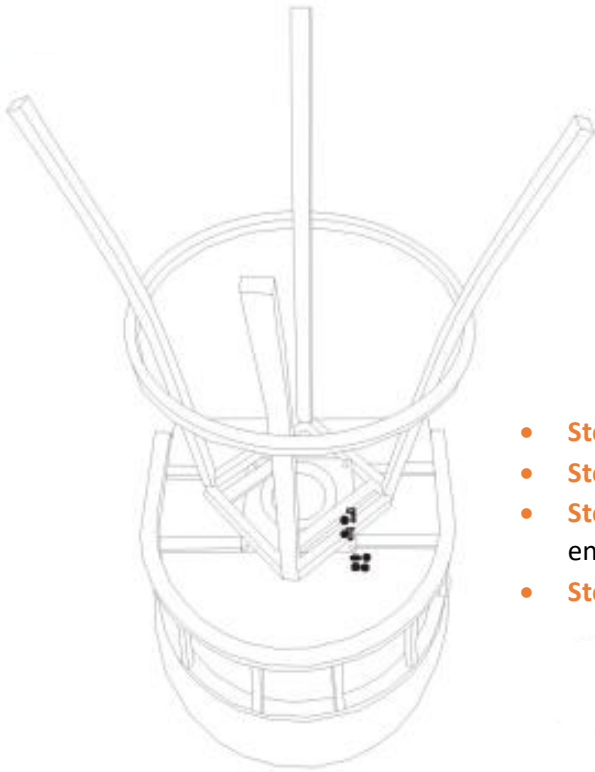





Product Assembly Instructions

Item#: Valerie Barstool

Helpers needed to assemble: 1

Estimate time frame to assemble: 20 minutes



#	Picture	Description	Quantity
1		Barstool Seat	1
2		Barstool legs	1
3		Allen Key	1
4		Screws (M6 *25)	4
5		Nuts (M6)	4
6		Gasket	4

- **Step 1:** Place the barstool Seat upside down on the floor as seen.
- **Step 2:** Align the barstool legs with the barstool seat holes
- **Step 3:** Please the gasket on the screw followed by the nut and proceed to enter the chair and leg insert.
- **Step 4:** Using the Allen key tighten the screw, until it firm and doesn't move.
 - Repeat steps 3 and 4 for each leg.

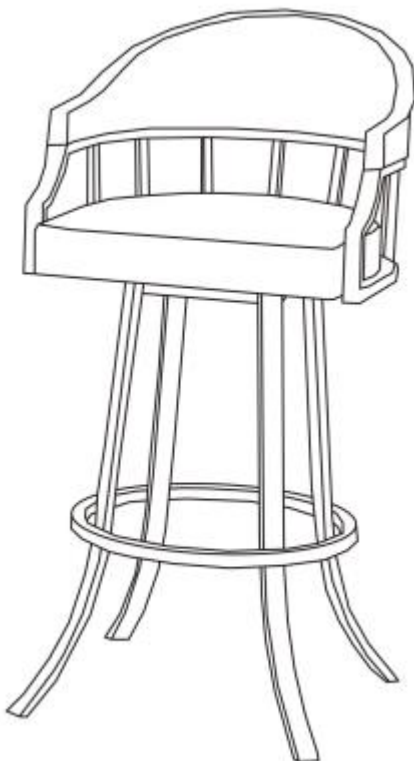

- **Step 5:** Flip the barstool over upright as seen.
- **Step 6:** Test the barstool is firmly on the ground and the seat does not wiggle.
- **Sep 7:** Sit and enjoy your new barstool.