

1\*1

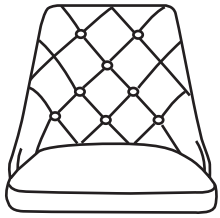

A\*4+1EXT

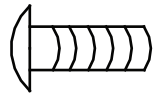

M6\*20mm

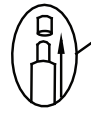

2

2\*1

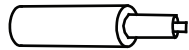

G\*1

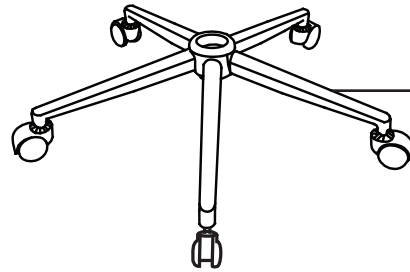
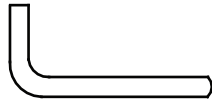

3

1

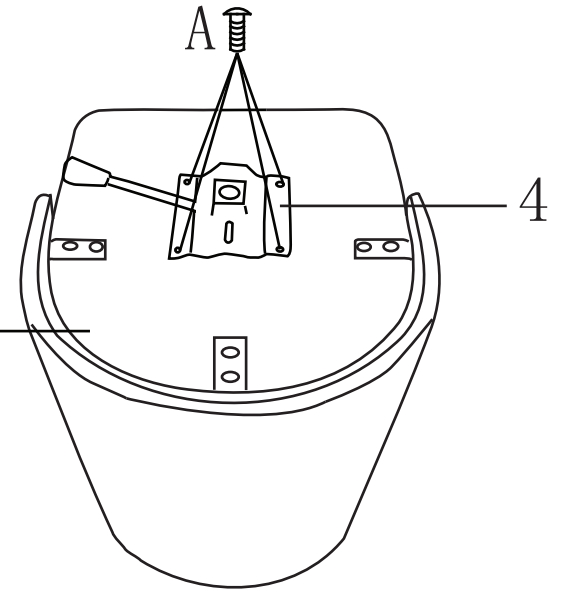

3\*1

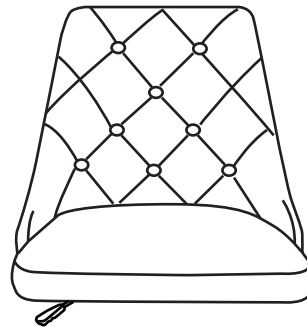
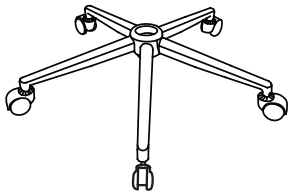

4\*1

