







Assmeby Instruction

1*1		A*4+1EXT	 M6*16MM
2*1		G*1	 M6
3*1			
4*1			
5*1			

STEP 1

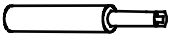
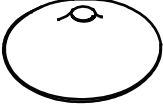

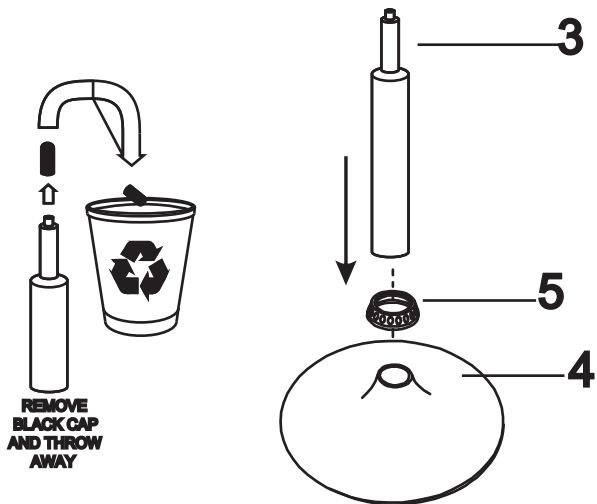
STEP 2

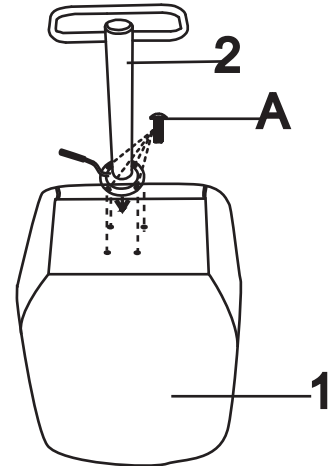

STEP 3

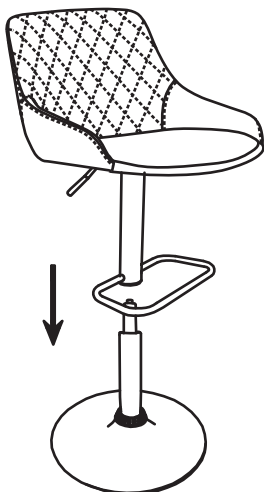

STEP 4

